

Issues with PD L1 initial release

NLN

Classification of glyphs

The “Container” class should maybe disappear

- Complex is an Entity Pool Node. The contained EPN are akin monomers in multimers
- Compartment is syntactically an Entity Pool Node
- Submap is syntactically a Process Node

Terminals of logical operators

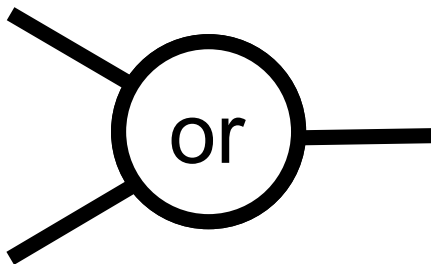
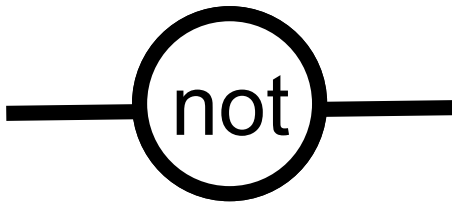
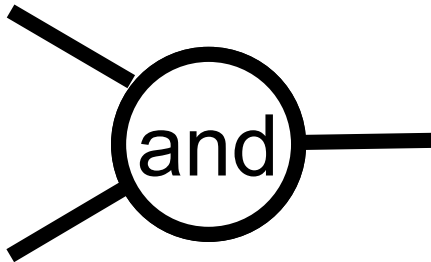

Terminals of logical operators

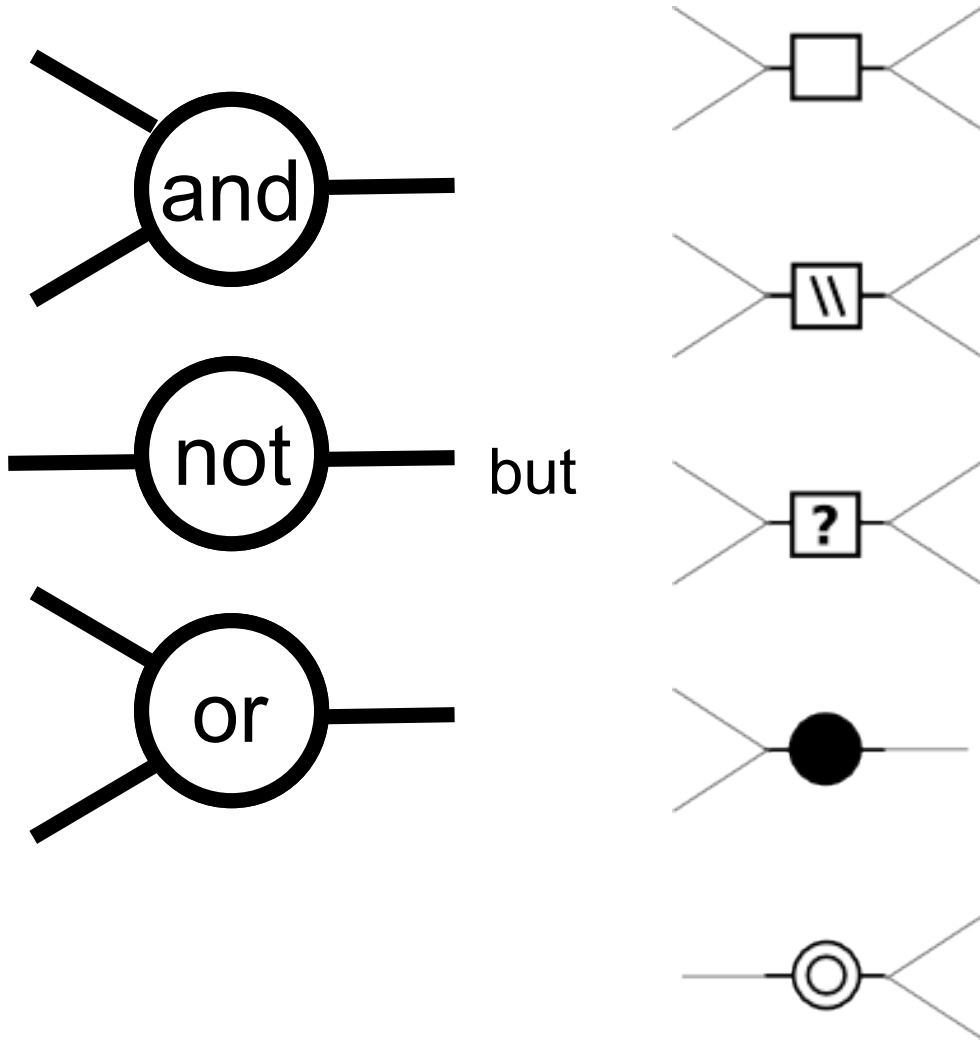

Terminals of logical operators

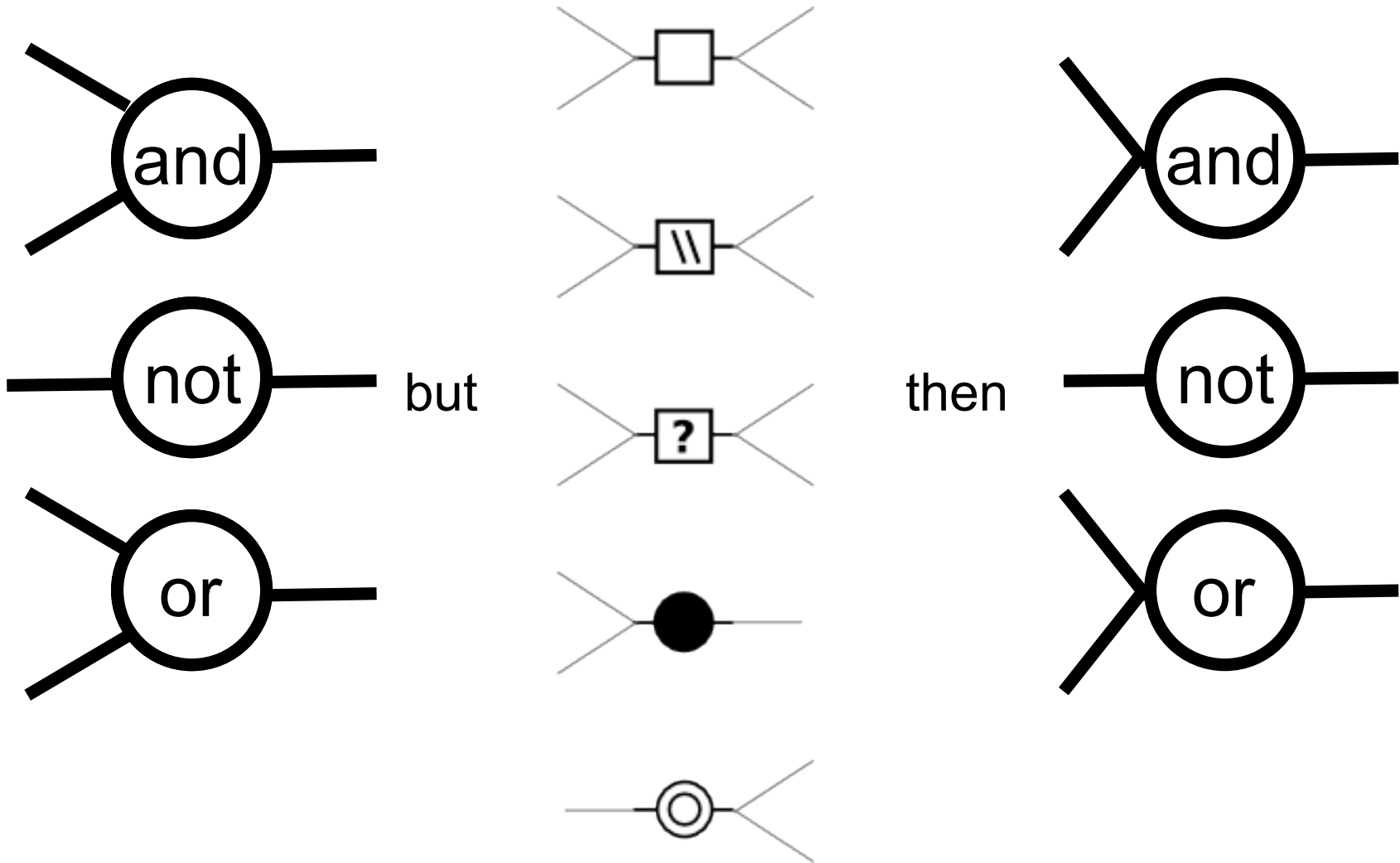

Shape of state variables

- Oval form came from the “generalisation” of circle
- Problem with long labels

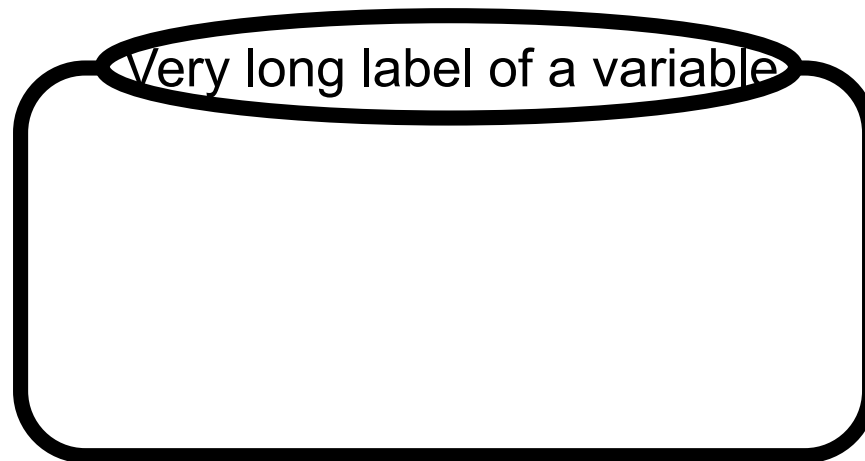

Proposition: The “sausage” is also derived from a circle

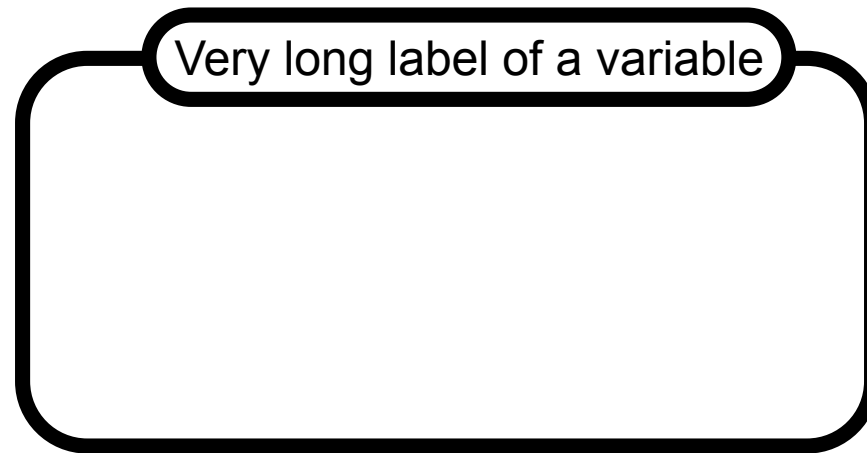

Slightly out of scope*: Delay

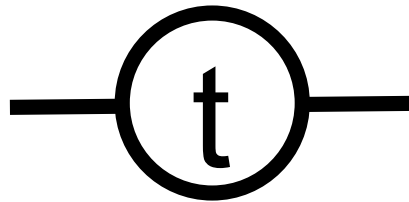

* but there is a reason. It was a criticism from the audience of CIBB. I still think it should not be part of a new release, rather a new level/version. But I want to keep it on the radar.